

ASSEMBLY INSTRUCTION

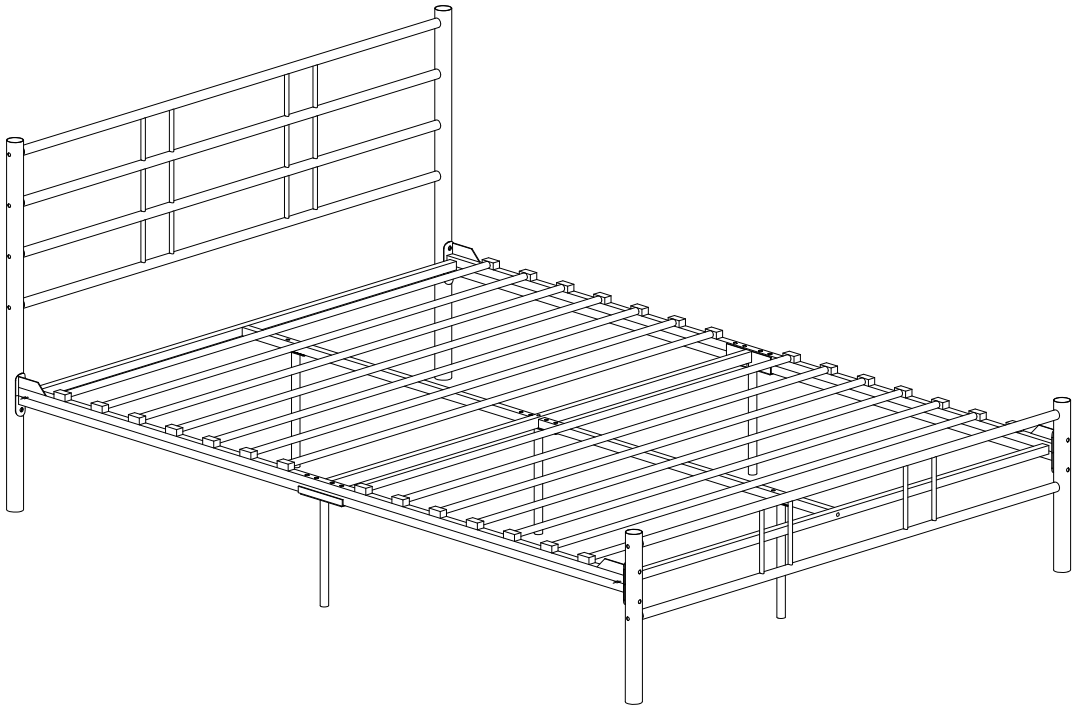

SIZE: 200×124×88.41CM (LWH)

Important Information

- **IMPORTANT - READ CAREFULLY - RETAIN THESE INSTRUCTIONS FOR FUTURE REFERENCE.**
- Due to the size of this product we recommend that it is assembled in the room intended for use.
- When you are ready to start, make sure that you have the right tools, plenty of space and a clean, dry area for assembly.
- Unwrap all packaging materials and place the components on top of the carton box or on a clean floor to prevent it from scratching.
- Check the pack and make sure you have all the parts listed.
- Ensure that this product is fully assembled and secured as illustrated before use.
- Check all screws or bolts are tightened and inspect regularly.
- This product should only be used on firm, level ground.
- Keep small parts out of reach of children.
- Make sure the legs remain in contact with the ground.
- Please dismantle for transportation
- Tools not included.

WARNINGS

- This product is intended for a maximum person's weight of 100kg per side. Do not exceed this weight.
- Do not use power tools to construct this product.
- Do not tighten screws until fully assembled.
- Do not over tighten screws or bolts.
- Do not use this product if parts are missing, damaged or worn.
- Do not stand on the product.

CARE INFORMATION

- Never use scourers, abrasives or chemical cleaners.
- To clean wipe with a sponge and warm soapy water. Do not use solvent based cleaners or detergents as they can bleach or damage the product.



2 Person Build

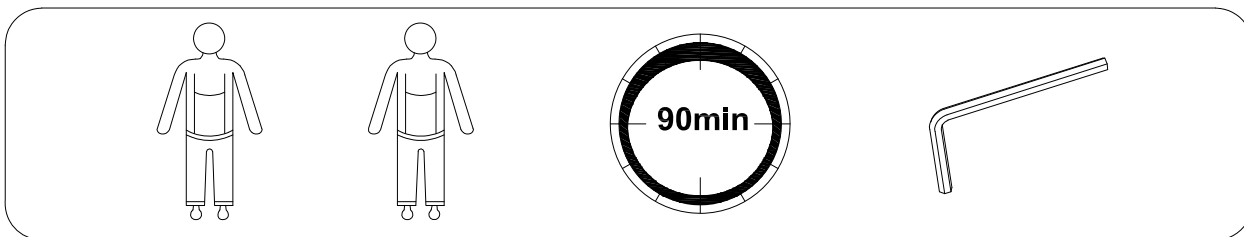
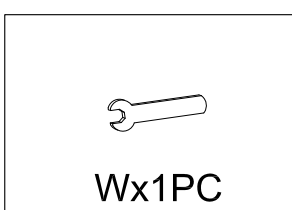
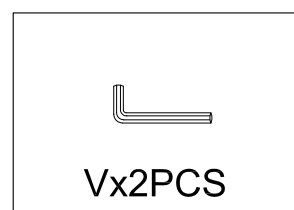
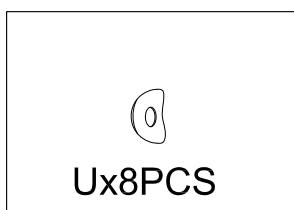
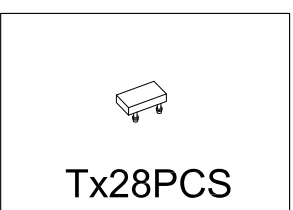
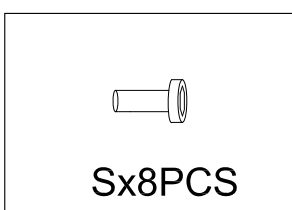
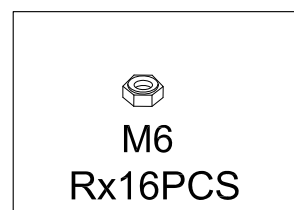
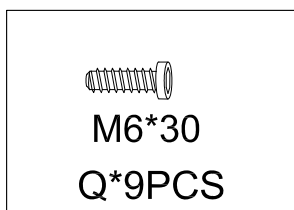
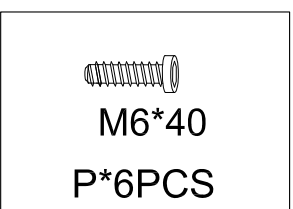
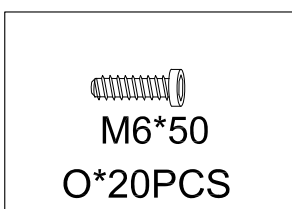
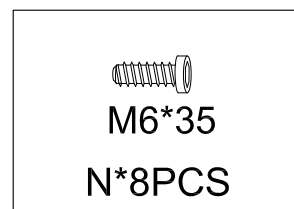
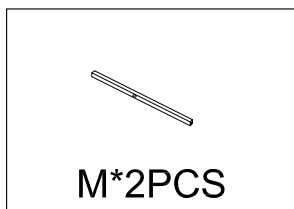
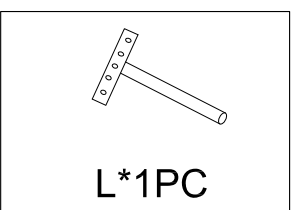
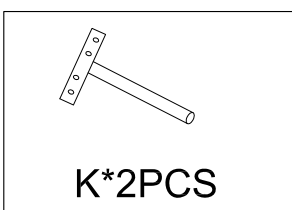
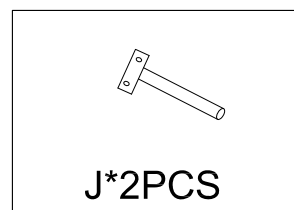
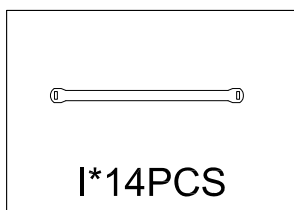
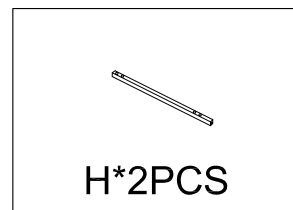
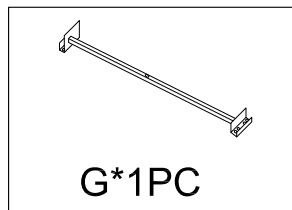
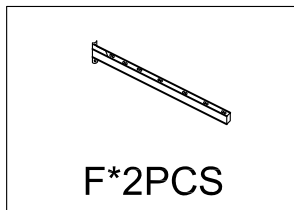
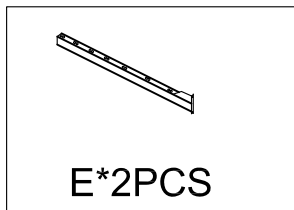
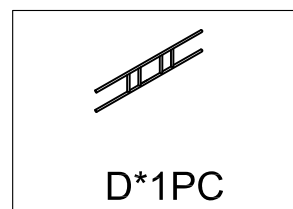
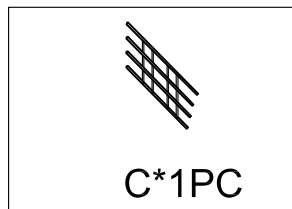
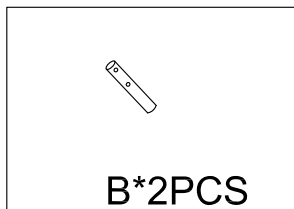
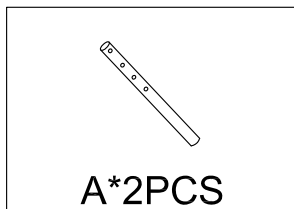

Step1

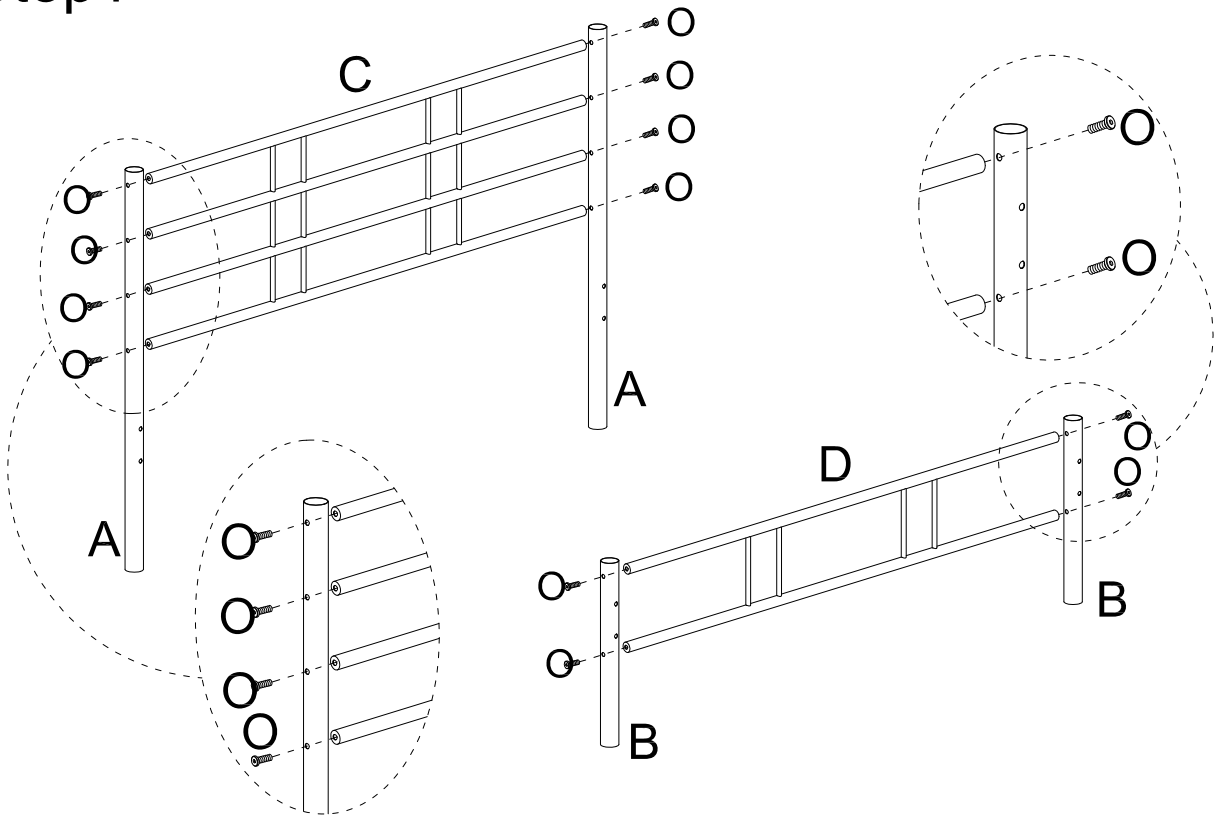

Step2

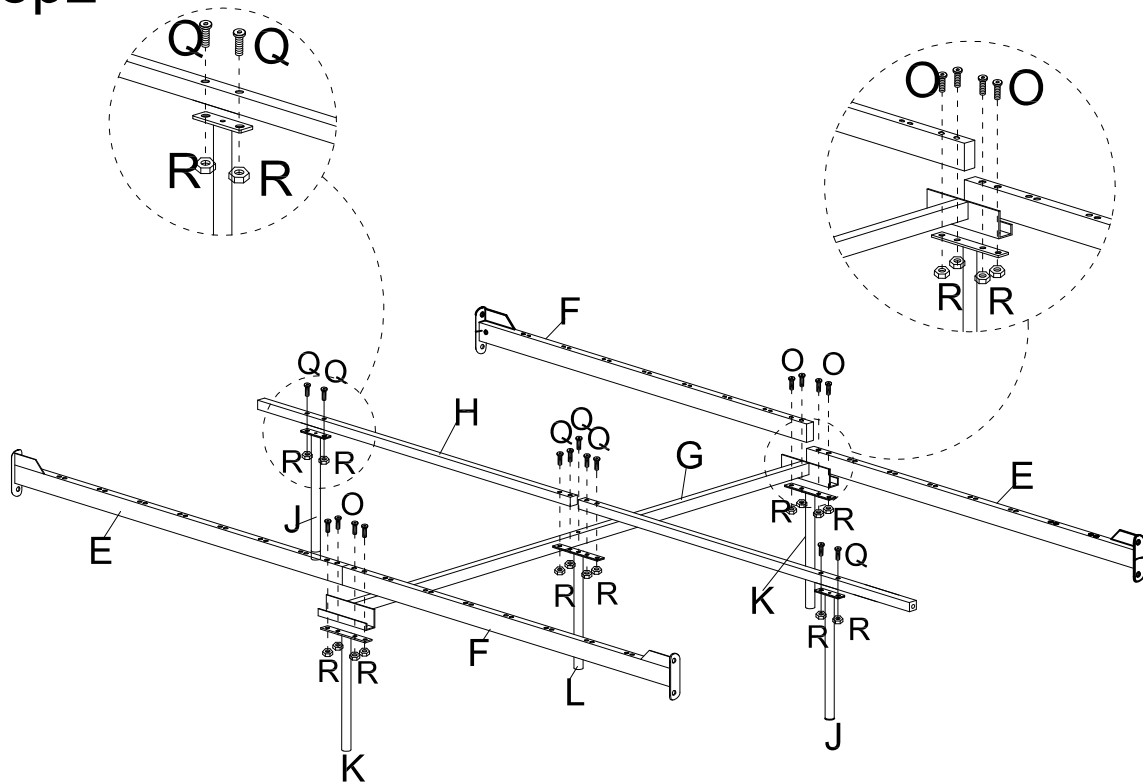

Step3

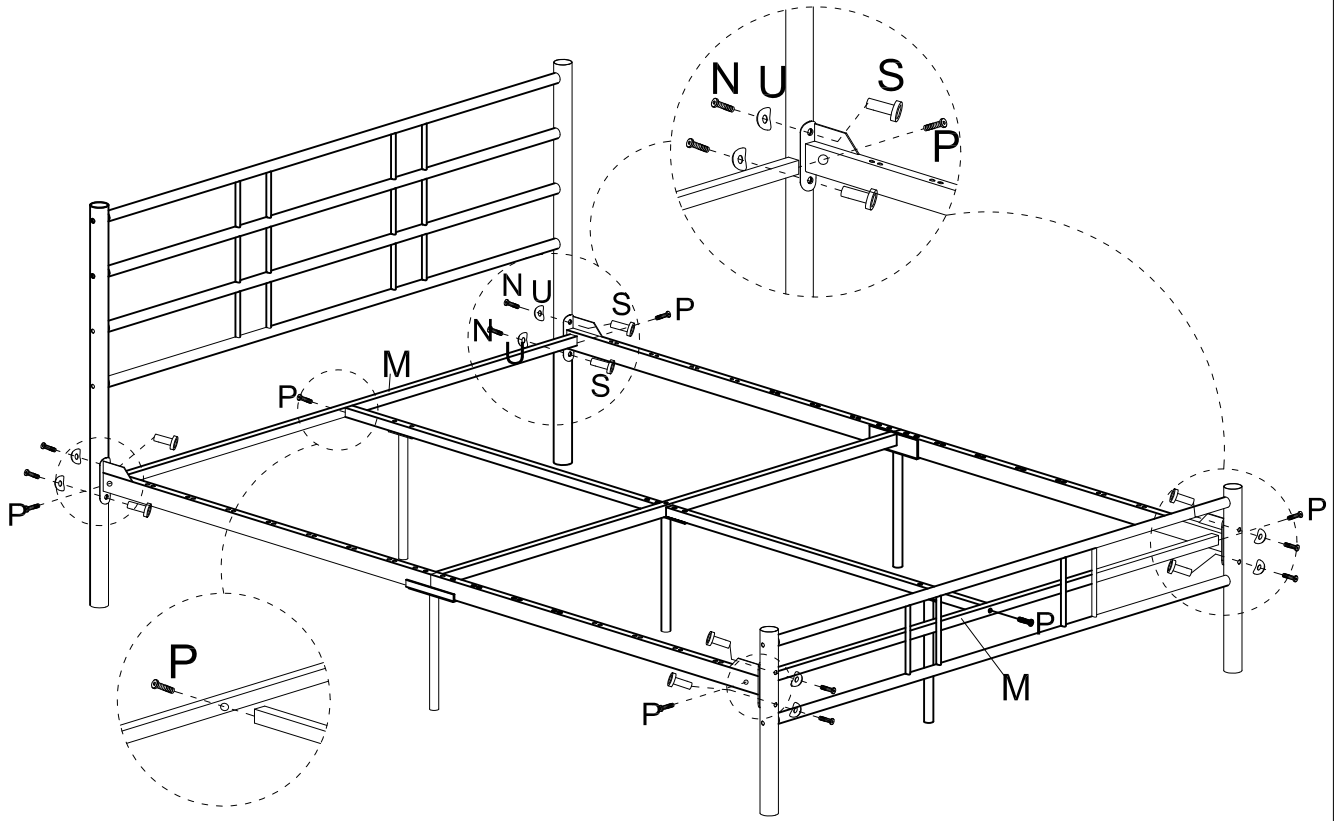

Step4

